

W 21.5 × H 28 mm Analog Timers

ATM Series

INSTRUCTION MANUAL

DRW201177AA

Autonics

Thank you for choosing our Autonics product.

Read and understand the instruction manual and manual thoroughly before using the product.

For your safety, read and follow the below safety considerations before using.

For your safety, read and follow the considerations written in the instruction manual, other manuals and Autonics website.

Keep this instruction manual in a place where you can find easily.

The specifications, dimensions, etc. are subject to change without notice for product improvement. Some models may be discontinued without notice.

Follow Autonics website for the latest information.

Safety Considerations

- Observe all 'Safety Considerations' for safe and proper operation to avoid hazards.
- ⚠ symbol indicates caution due to special circumstances in which hazards may occur.

⚠ Warning Failure to follow instructions may result in serious injury or death.

01. Fail-safe device must be installed when using the unit with machinery that may cause serious injury or substantial economic loss. (e.g. nuclear power control, medical equipment, ships, vehicles, railways, aircraft, combustion apparatus, safety equipment, crime/disaster prevention devices, etc.)
Failure to follow this instruction may result in personal injury, economic loss or fire.

02. Do not use the unit in the place where flammable/explosive/corrosive gas, high humidity, direct sunlight, radiant heat, vibration, impact or salinity may be present.

Failure to follow this instruction may result in explosion or fire.

03. Install on a device panel to use.

Failure to follow this instruction may result in fire or electric shock.

04. Do not connect, repair, or inspect the unit while connected to a power source.

Failure to follow this instruction may result in fire or electric shock.

05. Check 'Connections' before wiring.

Failure to follow this instruction may result in fire.

06. Do not disassemble or modify the unit.

Failure to follow this instruction may result in fire or electric shock.

⚠ Caution Failure to follow instructions may result in injury or product damage.

01. Use the unit within the rated specifications.

Failure to follow this instruction may result in fire or product damage.

02. Use a dry cloth to clean the unit, and do not use water or organic solvent.

Failure to follow this instruction may result in fire or electric shock.

03. Keep the product away from metal chip, dust, and wire residue which flow into the unit.

Failure to follow this instruction may result in fire or product damage.

Cautions during Use

- Follow instructions in 'Cautions during Use'. Otherwise, it may cause unexpected accidents.
- Power supply should be insulated and limited voltage/current or Class2, SELV power supply device.
- When supplying or turning off the power, use a switch or etc. to avoid chattering.
- Install a power switch or circuit breaker in the easily accessible place for supplying or disconnecting the power.
- In order to avoid leakage current flowing, connect resistance and condenser like below. Otherwise, it may cause malfunction.

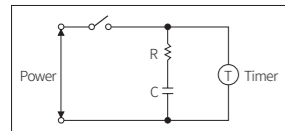

- After turning off the power, change the time range, etc.
- Keep away from high voltage lines or power lines to prevent inductive noise. In case installing power line and input signal line closely, use line filter or varistor at power line and shielded wire at input signal line.
Do not use near the equipment which generates strong magnetic force or high frequency noise.
- This unit may be used in the following environments.
 - Indoors (in the environment condition rated in 'Specifications')
 - Altitude max. 2,000 m
 - Pollution degree 2
 - Installation category II

Ordering Information

This is only for reference.

For selecting the specified model, follow the Autonics website.

ATM4 - ① ② ③

① Power supply

2: 24 VDC=
5: 220 VAC ~ 50 / 60 Hz
6: 110 VAC ~ 50 / 60 Hz

③ Time unit

S: SEC
M: MIN
H: HOUR

② Time range

Number: max. time

Dimensions

- Unit: mm, For the detailed drawings, follow the Autonics website.
- Mount the My socket (sold separately).

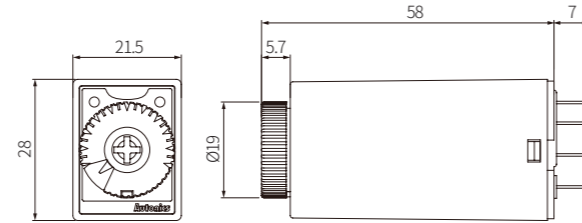

■ Pin arrangement

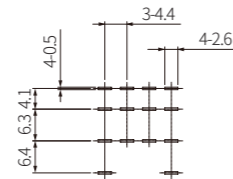

Unit Descriptions

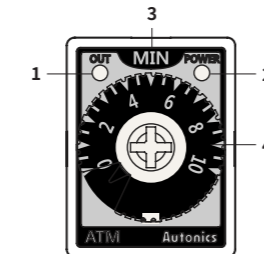

No.	Name
1	Output indicator (red)
2	Power indicator (green)
3	Time unit
4	Dial for the time setting

Time Range

Model	Time unit	Time range
ATM4-□1S	SEC	0.1 to 1
ATM4-□5S		0.5 to 5
ATM4-□10S		1 to 10
ATM4-□30S		3 to 30
ATM4-□60S		6 to 60
ATM4-□3M		0.3 to 3
ATM4-□5M	MIN	0.5 to 5
ATM4-□10M		1 to 10
ATM4-□30M		3 to 30
ATM4-□60M		6 to 60
ATM4-□3H	HOUR	0.3 to 3

Operation Timing Chart

- t: setting time, Rt: return time

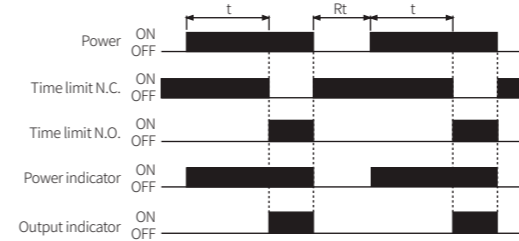

Connections

⚠ Caution
: See the 'Specifications' for checking the power supply and control output.

■ IEC marking

- This type of connection is marked on the product.

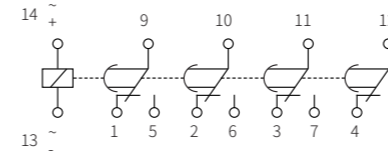

■ NEMA marking

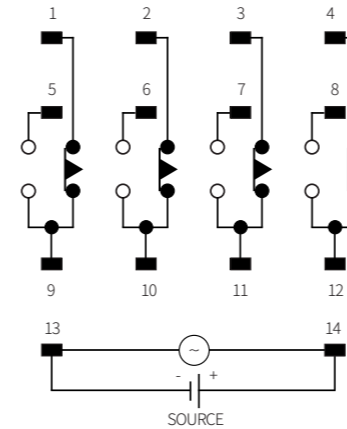

Specifications

Model	ATM4-2□□	ATM4-5□□	ATM4-6□□
Function	Power ON Delay		
Return time	≤ 100 ms		
Time operation	Power ON Start		
Control output	Relay		
Contact type	4PDT (4c)		
Contact capacity	250 VAC ~ 3 A, 24 VDC ~ 3 A resistive load		
Error	Repeat: ≤ ± 0.5% ± 10 ms SET: ≤ ± 10% ± 50 ms Voltage: ≤ ± 0.5% ± 10 ms Temp.: ≤ ± 2% ± 10 ms		
Approval	CE [R]		
Weight (packaging)	≈ 42 g (≈ 48 g)		

Power supply	24 VDC= 220 VAC ~ 50 / 60 Hz	110 VAC ~ 50 / 60 Hz
Allowable voltage range	21.6 - 26.4 VDC= 200 - 230 VAC ~ 50 / 60 Hz	100 - 120 VAC ~ 50 / 60 Hz
Power consumption	≈ 1.2 W	≈ 3 VA
Insulation resistive	≥ 100 MΩ (500 VDC = megger)	
Dielectric strength	3,000 VAC ~ at 50 / 60 Hz for 1 min	
Noise immunity	± 2 kV square-wave noise by noise simulator (pulse width 1 μs)	
Vibration	0.75 mm amplitude at frequency of 10 to 55 Hz (for 1 min) in each X, Y, Z direction for 1 hour	
Vibration (malfunction)	0.5 mm amplitude at frequency of 10 to 55 Hz (for 1 min) in each X, Y, Z direction for 10 min	
Shock	300 m/s ² (≈ 30 G) in each X, Y, Z direction for 3 times	
Shock (malfunction)	100 m/s ² (≈ 10 G) in each X, Y, Z direction for 3 times	
Relay life cycle	Mechanical: ≥ 10,000,000 operations Electrical: ≥ 200,000 operations	
Ambient temperature	-10 to 50 °C, storage: -25 to 65 °C (rated at no freezing or condensation)	
Ambient humidity	35 to 85%RH, storage: 35 to 85%RH (rated at no freezing or condensation)	